

**Data sheet | Item number: 765-4504/100-000**

4-Port-IO Link Master Class B; EtherNet/IP; DC 24 V / 2.0 A; 4xM12 connection; SlimLine

[www.wago.com/765-4504\\_100-000](http://www.wago.com/765-4504_100-000)

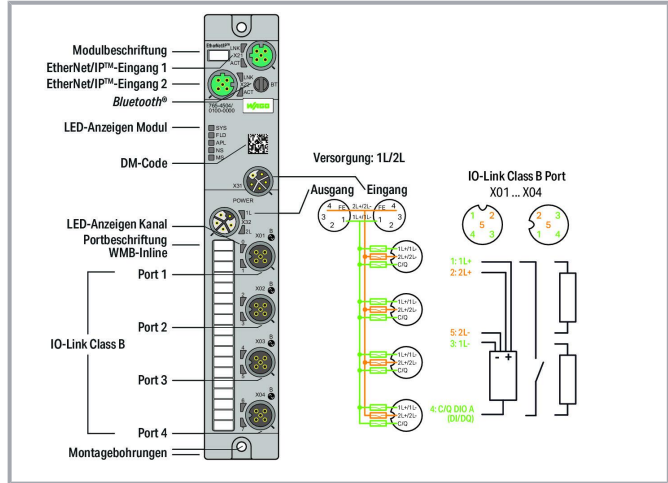

**Data**

**Technical data**

**Fieldbus**

Communication	EtherNet/IP™ BOOTP, DHCP, DLR
Connection technology: communication/fieldbus	2 x D-coded M12; 4-pole
Interface standard	10BASE-T/100BASE-TX; potential-free
Autonegotiation; autocrossover	yes

**Device Function**

Parameter	Input filter
-----------	--------------

Subject to changes. Please also observe the further product documentation!

WAGO Corporation  
 Germantown, WI 53022  
 Phone: 1-800-DIN-RAIL (346-7245) | Fax: (262) 255-6222  
 Email: [info.us@wago.com](mailto:info.us@wago.com) | Web: [www.wago.us](http://www.wago.us)

Do you have any questions about our products?  
 We are always happy to take your call at (262) 255-6222 or 1 800-DIN-RAIL.



	Output current Temperature
Diagnostics	Undervoltage; Overcurrent; Overload; Overtemperature
Device functions	Bluetooth® OPC UA Server
Visualization	Android/iOS app Webserver

## IO-Link Master

IO-Link Master classification	Class B; Specification V1.1
Port mode	IO-Link: autoconfig, manual, tool-based DI DO
Cycle time	400 µs (min.)
Operating mode	IO-Link master, DI or DO (adjustable for pin 4 per port); Supply voltage 2L (fixed for pin 2 per port)

## IO-Link ports

Number of digital inputs	8
Number of digital outputs	8
Connection technology: inputs / outputs	4 x A-coded M12; 5-pole
Voltage signal type	DC 24 V
Input characteristic	High-side switching
Input filter	0.2 ... 20 ms
Input characteristic	Type 3, per IEC 61131-2
Output current (per channel)	typ. 2 A for DO
Supply current per port	1L (Pin 1): 1 A for IO-Link; 4 A (max.) for DIO; 2L (Pin 2): 4 A (max.)

## Module Power Supply

Connection technology: supply	2 x L-coded M12; 5-pole
Supply voltage	24 VDC (18 ... 31.2 V); 1L/2L
Power consumption (max.)	16000 mA
Power consumption (note)	per supply line; overload- and short-circuit-protected
Reverse voltage protection	Yes

## Geometrical Data

Width	35 mm / 1.378 inch
Height	30 mm / 1.181 inch

Subject to changes. Please also observe the further product documentation!

WAGO Corporation  
Germantown, WI 53022  
Phone: 1-800-DIN-RAIL (346-7245) | Fax: (262) 255-6222  
Email: [info.us@wago.com](mailto:info.us@wago.com) | Web: [www.wago.us](http://www.wago.us)

Do you have any questions about our products?  
We are always happy to take your call at (262) 255-6222 or 1 800-DIN-RAIL.

Depth	210 mm / 8.268 inch
-------	---------------------

### Mechanical Data

Weight	380 g
Conformity marking	CE

### Environmental Requirements

Surrounding air temperature (operation)	-25 ... 70 °C
Surrounding air temperature (storage)	-40 ... 80 °C
Protection type	IP67
Protection class	III per EN 61140, IEC 61140, VDE 0140-1
Operating altitude	0 ... 2000 m
Pollution degree (5)	3 per EN 60664-1
Overvoltage category	II (EN 60664-1)
Relative humidity (without condensation)	95 %
Vibration resistance	5g per IEC 60068-2-6
Shock resistance	Short-term: 50g/11 ms/half-sine per IEC 60068-2-27; Long-term: 30g/6 ms/half-sine per IEC 60068-2-29
EMC immunity to interference	per EN 61000-6-2
EMC emission of interference	per EN 61000-6-4

### Commercial data

Packaging type	BOX
Country of origin	DE
GTIN	4055144010213
Customs tariff number	8537109170

### Required accessories

#### Tools

	<b>Item no.: 206-701</b> Torque wrench M8 and M12; Assembly kit	<a href="http://www.wago.com/206-701">www.wago.com/206-701</a>
--	--	--

#### Cover



<b>Item no.: 756-8102</b> M12 protective cap; for unused sockets	<a href="http://www.wago.com/756-8102">www.wago.com/756-8102</a>
---	--



<b>Item no.: 756-8103</b> M12 protective cap; for unused plugs	<a href="http://www.wago.com/756-8103">www.wago.com/756-8103</a>
---	--

### Marking accessories

Subject to changes. Please also observe the further product documentation!

WAGO Corporation  
Germantown, WI 53022  
Phone: 1-800-DIN-RAIL (346-7245) | Fax: (262) 255-6222  
Email: [info.us@wago.com](mailto:info.us@wago.com) | Web: [www.wago.us](http://www.wago.us)

Do you have any questions about our products?  
We are always happy to take your call at (262) 255-6222 or 1 800-DIN-RAIL.



**Item no.: 2009-110**

Marking strips; for Smart Printer; on reel; not stretchable; plain; snap-on type; white

[www.wago.com/2009-110](http://www.wago.com/2009-110)











**Item no.: 2009-115**

WMB-Inline; for Smart Printer; 1500 pieces on roll; stretchable 5 - 5.2 mm; plain; snap-on type; white

[www.wago.com/2009-115](http://www.wago.com/2009-115)

**Optional accessories**

**Cables and pluggable connectors**













	<b>Item no.: 756-1201/060-020</b> ETHERNET cable; M12D plug; straight; 4-pole; Length: 2 m	<a href="http://www.wago.com/756-1201/060-020">www.wago.com/756-1201/060-020</a>
	<b>Item no.: 756-1201/060-050</b> ETHERNET cable; M12D plug; straight; 4-pole; Length: 5 m	<a href="http://www.wago.com/756-1201/060-050">www.wago.com/756-1201/060-050</a>
	<b>Item no.: 756-1201/060-100</b> ETHERNET cable; M12D plug; straight; 4-pole; Length: 10 m	<a href="http://www.wago.com/756-1201/060-100">www.wago.com/756-1201/060-100</a>
	<b>Item no.: 756-1201/060-200</b> ETHERNET cable; M12D plug; straight; 4-pole; Length: 20 m	<a href="http://www.wago.com/756-1201/060-200">www.wago.com/756-1201/060-200</a>
	<b>Item no.: 756-1202/060-020</b> ETHERNET cable; M12D plug; angled; 4-pole; Length: 2 m	<a href="http://www.wago.com/756-1202/060-020">www.wago.com/756-1202/060-020</a>
	<b>Item no.: 756-1202/060-050</b> ETHERNET cable; M12D plug; angled; 4-pole; Length: 5 m	<a href="http://www.wago.com/756-1202/060-050">www.wago.com/756-1202/060-050</a>
	<b>Item no.: 756-1202/060-100</b> ETHERNET cable; M12D plug; angled; 4-pole; Length: 10 m	<a href="http://www.wago.com/756-1202/060-100">www.wago.com/756-1202/060-100</a>
	<b>Item no.: 756-1202/060-200</b> ETHERNET cable; M12D plug; angled; 4-pole; Length: 20 m	<a href="http://www.wago.com/756-1202/060-200">www.wago.com/756-1202/060-200</a>
	<b>Item no.: 756-1203/060-020</b> ETHERNET cable; M12D plug; straight; M12 plug, axial; 4-pole; Length: 2 m	<a href="http://www.wago.com/756-1203/060-020">www.wago.com/756-1203/060-020</a>
	<b>Item no.: 756-1203/060-050</b> ETHERNET cable; M12D plug; straight; M12 plug, axial; 4-pole; Length: 5 m	<a href="http://www.wago.com/756-1203/060-050">www.wago.com/756-1203/060-050</a>
	<b>Item no.: 756-1203/060-100</b> ETHERNET cable; M12D plug; straight; M12 plug, axial; 4-pole; Length: 10 m	<a href="http://www.wago.com/756-1203/060-100">www.wago.com/756-1203/060-100</a>

Subject to changes. Please also observe the further product documentation!

WAGO Corporation  
 Germantown, WI 53022  
 Phone: 1-800-DIN-RAIL (346-7245) | Fax: (262) 255-6222  
 Email: [info.us@wago.com](mailto:info.us@wago.com) | Web: [www.wago.us](http://www.wago.us)













Do you have any questions about our products?  
 We are always happy to take your call at (262) 255-6222 or 1 800-DIN-RAIL.



	<b>Item no.: 756-1203/060-200</b> ETHERNET cable; M12D plug; straight; M12 plug, axial; 4-pole; Length: 20 m	<a href="http://www.wago.com/756-1203/060-200">www.wago.com/756-1203/060-200</a>
	<b>Item no.: 756-1204/060-010</b> ETHERNET/PROFINET cable, angled; 1 m; fitted on both ends; D-coded; M12 plug, angled; M12 plug, angled	<a href="http://www.wago.com/756-1204/060-010">www.wago.com/756-1204/060-010</a>
	<b>Item no.: 756-1204/060-020</b> ETHERNET cable; M12D plug; angled; M12 plug, right angle; 4-pole; Length: 2 m	<a href="http://www.wago.com/756-1204/060-020">www.wago.com/756-1204/060-020</a>
	<b>Item no.: 756-1204/060-030</b> ETHERNET cable; M12D plug; angled; M12 plug, right angle; 4-pole; Length: 3 m	<a href="http://www.wago.com/756-1204/060-030">www.wago.com/756-1204/060-030</a>
	<b>Item no.: 756-1204/060-050</b> ETHERNET cable; M12D plug; angled; M12 plug, right angle; 4-pole; Length: 5 m	<a href="http://www.wago.com/756-1204/060-050">www.wago.com/756-1204/060-050</a>
	<b>Item no.: 756-1204/060-100</b> ETHERNET cable; M12D plug; angled; M12 plug, right angle; 4-pole; Length: 10 m	<a href="http://www.wago.com/756-1204/060-100">www.wago.com/756-1204/060-100</a>
	<b>Item no.: 756-1204/060-200</b> ETHERNET cable; M12D plug; angled; M12 plug, right angle; 4-pole; Length: 20 m	<a href="http://www.wago.com/756-1204/060-200">www.wago.com/756-1204/060-200</a>
	<b>Item no.: 756-3501/050-020</b> Power cable; M12L socket; straight; 5-pole; Length: 2 m	<a href="http://www.wago.com/756-3501/050-020">www.wago.com/756-3501/050-020</a>
	<b>Item no.: 756-3501/050-050</b> Power cable; M12L socket; straight; 5-pole; Length: 5 m	<a href="http://www.wago.com/756-3501/050-050">www.wago.com/756-3501/050-050</a>
	<b>Item no.: 756-3501/050-075</b> Power cable; M12L socket; straight; 5-pole; Length: 7.5 m	<a href="http://www.wago.com/756-3501/050-075">www.wago.com/756-3501/050-075</a>
	<b>Item no.: 756-3501/050-100</b> Power cable; M12L socket; straight; 5-pole; Length: 10 m	<a href="http://www.wago.com/756-3501/050-100">www.wago.com/756-3501/050-100</a>
	<b>Item no.: 756-3501/050-150</b> Power cable; M12L socket; straight; 5-pole; Length: 15 m	<a href="http://www.wago.com/756-3501/050-150">www.wago.com/756-3501/050-150</a>
	<b>Item no.: 756-3502/050-020</b> Power cable; M12L socket; angled; 5-pole; Length: 2 m	<a href="http://www.wago.com/756-3502/050-020">www.wago.com/756-3502/050-020</a>

Subject to changes. Please also observe the further product documentation!



 <b>Item no.: 756-3502/050-050</b> Power cable; M12L socket; angled; 5-pole; Length: 5 m	<a href="http://www.wago.com/756-3502/050-050">www.wago.com/756-3502/050-050</a>
 <b>Item no.: 756-3502/050-075</b> Power cable; M12L socket; angled; 5-pole; Length: 7.5 m	<a href="http://www.wago.com/756-3502/050-075">www.wago.com/756-3502/050-075</a>
 <b>Item no.: 756-3502/050-100</b> Power cable; M12L socket; angled; 5-pole; Length: 10 m	<a href="http://www.wago.com/756-3502/050-100">www.wago.com/756-3502/050-100</a>
 <b>Item no.: 756-3502/050-150</b> Power cable; M12L socket; angled; 5-pole; Length: 15 m	<a href="http://www.wago.com/756-3502/050-150">www.wago.com/756-3502/050-150</a>
 <b>Item no.: 756-3503/050-020</b> Power cable; M12L plug; straight; 5-pole; Length: 2 m	<a href="http://www.wago.com/756-3503/050-020">www.wago.com/756-3503/050-020</a>
 <b>Item no.: 756-3503/050-050</b> Power cable; M12L plug; straight; 5-pole; Length: 5 m	<a href="http://www.wago.com/756-3503/050-050">www.wago.com/756-3503/050-050</a>
 <b>Item no.: 756-3503/050-075</b> Power cable; M12L plug; straight; 5-pole; Length: 7.5 m	<a href="http://www.wago.com/756-3503/050-075">www.wago.com/756-3503/050-075</a>
 <b>Item no.: 756-3503/050-100</b> Power cable; M12L plug; straight; 5-pole; Length: 10 m	<a href="http://www.wago.com/756-3503/050-100">www.wago.com/756-3503/050-100</a>
 <b>Item no.: 756-3503/050-150</b> Power cable; M12L plug; straight; 5-pole; Length: 15 m	<a href="http://www.wago.com/756-3503/050-150">www.wago.com/756-3503/050-150</a>
 <b>Item no.: 756-3504/050-020</b> Power cable; M12L plug; angled; 5-pole; Length: 2 m	<a href="http://www.wago.com/756-3504/050-020">www.wago.com/756-3504/050-020</a>
 <b>Item no.: 756-3504/050-050</b> Power cable; M12L plug; angled; 5-pole; Length: 5 m	<a href="http://www.wago.com/756-3504/050-050">www.wago.com/756-3504/050-050</a>
 <b>Item no.: 756-3504/050-075</b> Power cable; M12L plug; angled; 5-pole; Length: 7.5 m	<a href="http://www.wago.com/756-3504/050-075">www.wago.com/756-3504/050-075</a>
 <b>Item no.: 756-3504/050-100</b> Power cable; M12L plug; angled; 5-pole; Length: 10 m	<a href="http://www.wago.com/756-3504/050-100">www.wago.com/756-3504/050-100</a>

Subject to changes. Please also observe the further product documentation!



↙	<b>Item no.: 756-3504/050-150</b> Power cable; M12L plug; angled; 5-pole; Length: 15 m	<a href="http://www.wago.com/756-3504/050-150">www.wago.com/756-3504/050-150</a>
↘	<b>Item no.: 756-3505/050-003</b> Power cable; M12L socket; straight; M12L plug; straight; 5-pole; Length: 0.3 m	<a href="http://www.wago.com/756-3505/050-003">www.wago.com/756-3505/050-003</a>
↘	<b>Item no.: 756-3505/050-005</b> Power cable; M12L socket; straight; M12L plug; straight; 5-pole; Length: 0.5 m	<a href="http://www.wago.com/756-3505/050-005">www.wago.com/756-3505/050-005</a>
↘	<b>Item no.: 756-3505/050-010</b> Power cable; M12L socket; straight; M12L plug; straight; 5-pole; Length: 1 m	<a href="http://www.wago.com/756-3505/050-010">www.wago.com/756-3505/050-010</a>
↘	<b>Item no.: 756-3505/050-020</b> Power cable; M12L socket; straight; M12L plug; straight; 5-pole; Length: 2 m	<a href="http://www.wago.com/756-3505/050-020">www.wago.com/756-3505/050-020</a>
↘	<b>Item no.: 756-3505/050-050</b> Power cable; M12L socket; straight; M12L plug; straight; 5-pole; Length: 5 m	<a href="http://www.wago.com/756-3505/050-050">www.wago.com/756-3505/050-050</a>
↘	<b>Item no.: 756-3505/050-075</b> Power cable; M12L socket; straight; M12L plug; straight; 5-pole; Length: 7.5 m	<a href="http://www.wago.com/756-3505/050-075">www.wago.com/756-3505/050-075</a>
↘	<b>Item no.: 756-3505/050-100</b> Power cable; M12L socket; straight; M12L plug; straight; 5-pole; Length: 10 m	<a href="http://www.wago.com/756-3505/050-100">www.wago.com/756-3505/050-100</a>
↘	<b>Item no.: 756-3505/050-150</b> Power cable; M12L socket; straight; M12L plug; straight; 5-pole; Length: 15 m	<a href="http://www.wago.com/756-3505/050-150">www.wago.com/756-3505/050-150</a>
↘	<b>Item no.: 756-3506/050-003</b> Power cable; M12L socket; angled; M12L plug; angled; 5-pole; Length: 0.3 m	<a href="http://www.wago.com/756-3506/050-003">www.wago.com/756-3506/050-003</a>
↘	<b>Item no.: 756-3506/050-005</b> Power cable; M12L socket; angled; M12L plug; angled; 5-pole; Length: 0.5 m	<a href="http://www.wago.com/756-3506/050-005">www.wago.com/756-3506/050-005</a>
↘	<b>Item no.: 756-3506/050-010</b> Power cable; M12L socket; angled; M12L plug; angled; 5-pole; Length: 1 m	<a href="http://www.wago.com/756-3506/050-010">www.wago.com/756-3506/050-010</a>
↘	<b>Item no.: 756-3506/050-020</b> Power cable; M12L socket; angled; M12L plug; angled; 5-pole; Length: 2 m	<a href="http://www.wago.com/756-3506/050-020">www.wago.com/756-3506/050-020</a>













Subject to changes. Please also observe the further product documentation!



↷	<b>Item no.: 756-3506/050-050</b> Power cable; M12L socket; angled; M12L plug; angled; 5-pole; Length: 5 m	<a href="http://www.wago.com/756-3506/050-050">www.wago.com/756-3506/050-050</a>
↷	<b>Item no.: 756-3506/050-075</b> Power cable; M12L socket; angled; M12L plug; angled; 5-pole; Length: 7.5 m	<a href="http://www.wago.com/756-3506/050-075">www.wago.com/756-3506/050-075</a>
↷	<b>Item no.: 756-3506/050-100</b> Power cable; M12L socket; angled; M12L plug; angled; 5-pole; Length: 10 m	<a href="http://www.wago.com/756-3506/050-100">www.wago.com/756-3506/050-100</a>
↷	<b>Item no.: 756-3506/050-150</b> Power cable; M12L socket; angled; M12L plug; angled; 5-pole; Length: 15 m	<a href="http://www.wago.com/756-3506/050-150">www.wago.com/756-3506/050-150</a>
✓	<b>Item no.: 756-5311/050-015</b> Sensor/Actuator cable; M12A plug; straight; 5-pole; Length: 1.5 m	<a href="http://www.wago.com/756-5311/050-015">www.wago.com/756-5311/050-015</a>
✓	<b>Item no.: 756-5311/050-050</b> Sensor/Actuator cable; M12A plug; straight; 5-pole; Length: 5 m	<a href="http://www.wago.com/756-5311/050-050">www.wago.com/756-5311/050-050</a>
✓	<b>Item no.: 756-5311/050-100</b> Sensor/Actuator cable; M12A plug; straight; 5-pole; Length: 10 m	<a href="http://www.wago.com/756-5311/050-100">www.wago.com/756-5311/050-100</a>
✓	<b>Item no.: 756-5312/050-015</b> Sensor/Actuator cable; M12B socket; straight; 5-pole; Length: 1.5 m	<a href="http://www.wago.com/756-5312/050-015">www.wago.com/756-5312/050-015</a>
✓	<b>Item no.: 756-5312/050-050</b> Sensor/Actuator cable; M12B socket; straight; 5-pole; Length: 5 m	<a href="http://www.wago.com/756-5312/050-050">www.wago.com/756-5312/050-050</a>
✓	<b>Item no.: 756-5312/050-100</b> Sensor/Actuator cable; M12B socket; straight; 5-pole; Length: 10 m	<a href="http://www.wago.com/756-5312/050-100">www.wago.com/756-5312/050-100</a>
⊖	<b>Item no.: 756-5401/050-010</b> Sensor/Actuator cable; M12A socket; straight; M12A plug; straight; 5-pole; Length: 1 m	<a href="http://www.wago.com/756-5401/050-010">www.wago.com/756-5401/050-010</a>
⊖	<b>Item no.: 756-5401/050-020</b> Sensor/Actuator cable; M12A socket; straight; M12A plug; straight; 5-pole; Length: 2 m	<a href="http://www.wago.com/756-5401/050-020">www.wago.com/756-5401/050-020</a>
⊖	<b>Item no.: 756-5402/050-010</b> Sensor/Actuator cable; M12A socket; straight; M12A plug; angled; 5-pole; Length: 1 m	<a href="http://www.wago.com/756-5402/050-010">www.wago.com/756-5402/050-010</a>

Subject to changes. Please also observe the further product documentation!



	<b>Item no.: 756-5402/050-020</b> Sensor/Actuator cable; M12A socket; straight; M12A plug; angled; 5-pole; Length: 2 m	<a href="http://www.wago.com/756-5402/050-020">www.wago.com/756-5402/050-020</a>
	<b>Item no.: 756-5403/050-010</b> Sensor/Actuator cable; M12A socket; angled; M12A plug; straight; 5-pole; Length: 1 m	<a href="http://www.wago.com/756-5403/050-010">www.wago.com/756-5403/050-010</a>
	<b>Item no.: 756-5403/050-020</b> Sensor/Actuator cable; M12A socket; angled; M12A plug; straight; 5-pole; Length: 2 m	<a href="http://www.wago.com/756-5403/050-020">www.wago.com/756-5403/050-020</a>
	<b>Item no.: 756-5404/050-010</b> Sensor/Actuator cable; M12A socket; angled; M12A plug; angled; 5-pole; Length: 1 m	<a href="http://www.wago.com/756-5404/050-010">www.wago.com/756-5404/050-010</a>
	<b>Item no.: 756-5404/050-020</b> Sensor/Actuator cable; M12A socket; angled; M12A plug; angled; 5-pole; Length: 2 m	<a href="http://www.wago.com/756-5404/050-020">www.wago.com/756-5404/050-020</a>
	<b>Item no.: 756-9202/050-000</b> Accessories; 5-pole	<a href="http://www.wago.com/756-9202/050-000">www.wago.com/756-9202/050-000</a>
	<b>Item no.: 756-9205/050-000</b> Accessories; 5-pole	<a href="http://www.wago.com/756-9205/050-000">www.wago.com/756-9205/050-000</a>
	<b>Item no.: 756-9301/050-000</b> Accessories; 5-pole	<a href="http://www.wago.com/756-9301/050-000">www.wago.com/756-9301/050-000</a>
	<b>Item no.: 756-9501/040-000</b> Accessories; M12 plug, right angle; 4-pole	<a href="http://www.wago.com/756-9501/040-000">www.wago.com/756-9501/040-000</a>
	<b>Item no.: 756-9501/060-000</b> Fitted pluggable connector; 4-pole, shielded; M12 plug, straight, D-coded; Spring	<a href="http://www.wago.com/756-9501/060-000">www.wago.com/756-9501/060-000</a>
	<b>Item no.: 756-9701/050-000</b> Fitted pluggable connector; 5-pole; M12 plug, straight; IDC technology	<a href="http://www.wago.com/756-9701/050-000">www.wago.com/756-9701/050-000</a>
	<b>Item no.: 756-9711/050-000</b> Fitted pluggable connector; 5-pole; M12 socket, straight; IDC technology	<a href="http://www.wago.com/756-9711/050-000">www.wago.com/756-9711/050-000</a>

Subject to changes. Please also observe the further product documentation!



## Downloads

### Documentation

#### Manual

4-Port IO-Link Master Class B; EtherNet/IP DC 24 V / 2.0 A; 4xM12 Connection; SlimLine	V 1.1.0 Apr 20, 2021	pdf 6.3 MB	Download
---	-------------------------	---------------	----------

#### System Description

WAGO I/O System Field; General Product Information		pdf 708.2 kB	Download
--	--	-----------------	----------

## Engineering-Software

### WAGO IO-Link Configurator

WAGO IO-Link Configurator	V5.1.1 Dec 17, 2020	ZIP 25.2 MB	Download
---------------------------	------------------------	----------------	----------

The WAGO IO-Link Configurator is standalone commissioning, configuration and management software for the WAGO Field I/O System's IO-Link Master and Hubs.

It supports all IO-Link devices per the IO-Link specification and allows automatic download of IODDs via integrated IODD Finder.

Register now and test our engineering software for 30 days at no cost.

## Environmental Product Compliance

### Compliance Search

Environmental Product Compliance 765-4504/100-000 4-Port-IO Link Master Class B; EtherNet/IP; DC 24 V / 2.0 A; 4xM12 connection; SlimLine		URL	Download
---	--	-----	----------

## Installation Notes

### Product family

**I/O System Field**  
[Show all products from the family](#)

Subject to changes. Please also observe the further product documentation!

WAGO Corporation  
Germantown, WI 53022  
Phone: 1-800-DIN-RAIL (346-7245) | Fax: (262) 255-6222  
Email: [info.us@wago.com](mailto:info.us@wago.com) | Web: [www.wago.us](http://www.wago.us)

Do you have any questions about our products?  
We are always happy to take your call at (262) 255-6222 or 1 800-DIN-RAIL.